

Features

- Low gate charge
- Low C_{RSS} (typ 9pF)
- Fast switchin
- 100% avalanche tested
- Improved dv/dt capability
- RoHS product

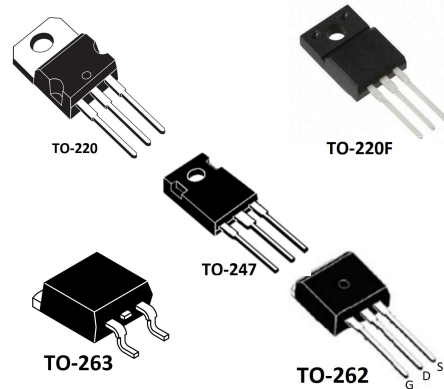

Applications

- High frequency switching mode power supply
- Electronic ballast
- UPS

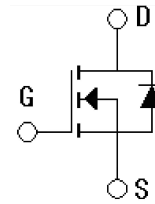

Absolute Ratings (Tc=25°C)

Parameter	Symbol	Value	Unit
Drain-Source Voltage	V_{DSS}	1000	V
Drain Current-continuous	I_D T=25°C T=100°C	8	A
		5	A
Drain Current-pulse (note 1)	I_{DM}	32*	A
Gate-Source Voltage	V_{GS}	±30	V
Single pulse avalanche energy(note 2)	E_{AS}	650	mJ
Avalanche Current (note 1)	I_{AR}	8	A
Repetitive Avalanche Energy(note 1)	E_{AR}	393	mJ
Power Dissipation (TO-220\TO-247)	PD TC=25°C Derate above 25°C	167	W
		1.43	W/°C
Power Dissipation (TO-263\TO-262)	PD TC=25°C Derate above 25°C	83	W
		0.34	W/°C
Power Dissipation (TO-220F)	PD TC=25°C Derate above 25°C	31.7	W
		0.25	W/°C
Operating and Storage Temperature Range	T_J, T_{STG}	-55~+150	°C

Peak Diode Recovery dv/dt (note 3)	dv/dt	4.5	V/ns
Maximum Lead Temperature for Soldering Purposes	T _L	300	°C

*Drain current limited by maximum junction temperature

Electrical Characteristics(T_{CASE}=25°C unless otherwise specified)

Parameter	Symbol	Tests conditions	Min	Type	Max	Units
Drain-Source Voltage	BV _{DSS}	I _D =250μA, V _{GS} =0V	1000	-	-	V
Breakdown Voltage Temperature Coefficient	ΔBV _{DSS} /ΔT _J	I _D =250μA, referenced to 25°C	-	1.05	-	V/°C
Zero Gate Voltage Drain Current	I _{DSS}	V _{DS} =1000V, V _{GS} =0V, T _C =25°C	-	-	1	μA
		V _{DS} =800V, T _C =125°C	-	-	10	μA
Gate body leakage current	I _{GSS}	V _{DS} =0V, V _{GS} =±30V	-	-	±100	nA

On-Characteristics

Gate Threshold Voltage	V _{GS(th)}	V _{DS} =V _{GS} , I _D =250μA	3.0	-	5.0	V
Static Drain-Source On-Resistance	R _{DS(ON)}	V _{GS} =10V, I _D =4A	-	1.8	2.3	Ω
Forward Transconductance	g _{FS}	V _{DS} =40V, I _D =4A (note 4)	-	5.6	-	S

Dynamic Characteristics

Input capacitance	C _{iss}	V _{DS} =25V, V _{GS} =0V, f=1.0MHZ	-	687	-	pF
Output capacitance	C _{oss}		-	67	-	pF
Reverse transfer capacitance	C _{riss}		-	12	-	pF

Electrical Characteristics(T_{CASE}=25°C unless otherwise specified)

Parameter	Symbol	Tests conditions	Min	Type	Max	Units
Switching-Characteristics						
Turn-On delay time	t _{d(on)}	V _{DD} =500V, I _D =8A, R _{GEN} =25Ω (note 4,5)	-	13	-	ns
Turn-On rise time	t _r		-	22	-	ns
Turn-Off delay time	t _{d(off)}		-	63	-	ns
Turn-Off rise time	t _f		-	19	-	ns

Total Gate Charge	Q_g	$V_{DS}=750V, I_D=4A,$ $V_{GS}=10V$ (note 4,5)	-	14	-	nC
Gate-Source charge	Q_{gs}		-	4	-	nC
Gate-Drain charge	Q_{gd}		-	5	-	nC
Drain-Source Diode Characteristics and Maximum Ratings						
Diode Forward Voltage (note 3)	V_{SD}	$V_{GS}=0V, I_S=8A$	-	-	1.4	V
Maximum Pulsed Drain-Source Diode Forward Current	I_{SM}	-	-	-	24	A
Maximum Continuous Drain Source Diode Forward Current	I_S	-	-	-	8	A
Reverse recovery time	t_{rr}	$V_{GS}=0V,$ $I_S=4A \text{ di}/dt=100A/\mu s$	-	159	-	ns
Reverse recovery charge	Q_{rr}	$T_c=25^\circ C$ (note 4)	-	693	-	nC
Reverse recovery time	t_{rr}	$V_{GS}=0V,$ $I_S=3A \text{ di}/dt=100A/\mu s$	-	153	-	ns
Reverse recovery charge	Q_{rr}	$T_c=100^\circ C$ (note 4)	-	685	-	nC

Thermal Characteristic

Parameter	Symbol	Value			Unit
		TO-220/ TO-247	TO-263/ TO-262	TO-220F	
Thermal Resistance, junction to Case	$R_{th(j-C)}$	0.78	3	3.94	$^\circ C/W$
Thermal Resistance, Junction to Ambient	$R_{th(j-A)}$	62.5	65	80	$^\circ C/W$

Order Message

Marking	Package
SL8N100K	TO-263
SL8N100H	TO-262
SL8N100F	TO-220F
SL8N100	TO-220
SL8N100T	TO-247

Notes:

1. Pulse width limited by maximum junction temperature
2. $L=33.0mH, I_{AS}=8A, V_{DD}=50V, R_G=25 \Omega, \text{Starting } T_J=25^\circ C$
3. $I_{SD} \leq 8A, di/dt \leq 200A/\mu s, V_{DD} \leq BV_{DSS}, \text{Starting } T_J=25^\circ C$
4. Pulse Test: Pulse Width $\leq 300\mu s, \text{Duty Cycle} \leq 2\%$

5. Essentially independent of operating temperature

ELECTRICAL CHARACTERISTICS (curves)

On-Region Characteristics

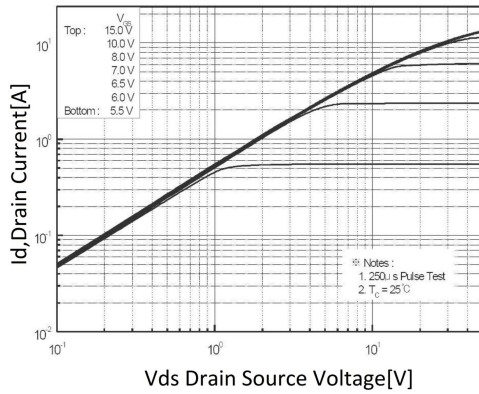

Transfer Characteristics

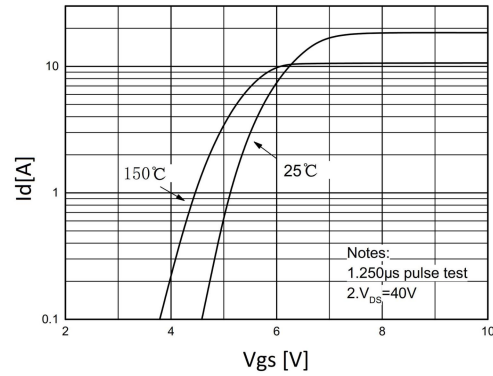

On-Resistance Variation vs. Drain Current and Gate Voltage

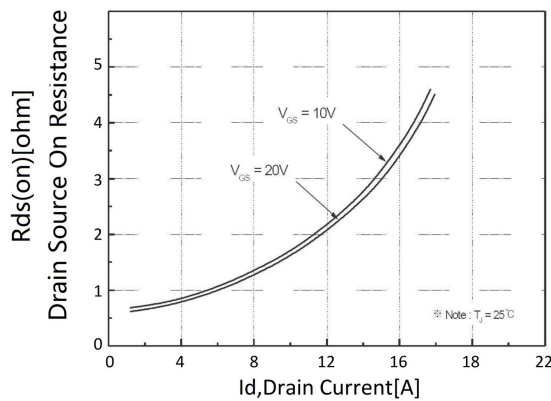

Body Diode Forward Voltage Variation vs. Source Current and Temperature

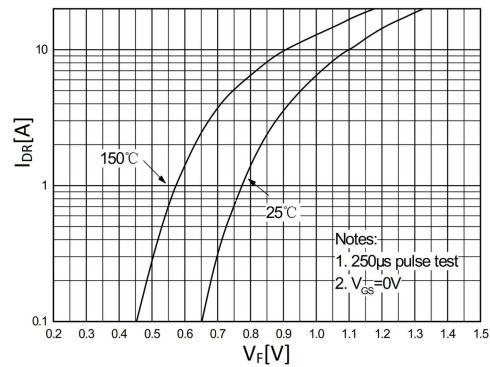

Capacitance Characteristics

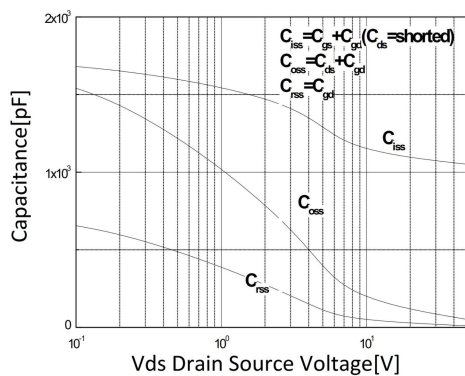

Gate Charge Characteristics

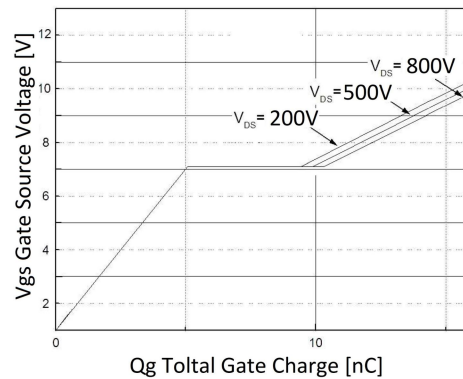

Breakdown Voltage Variation vs. Temperature

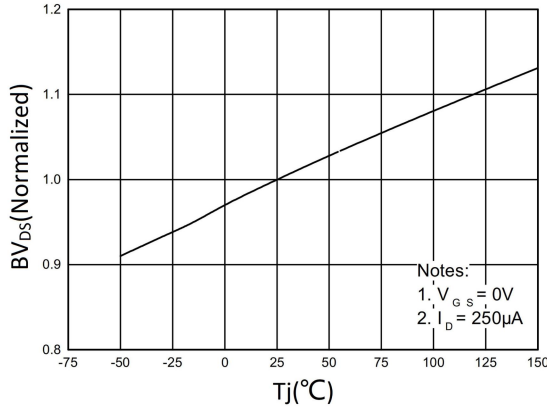

On-Resistance Variation vs. Temperature

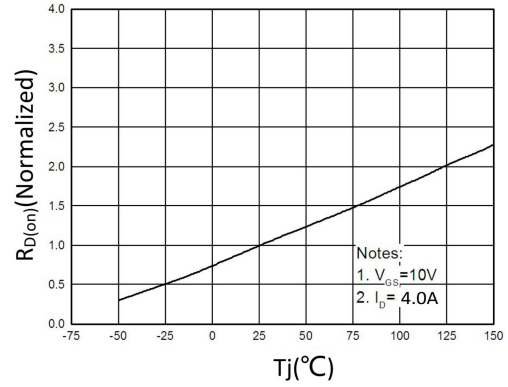

Maximum Safe Operating Area

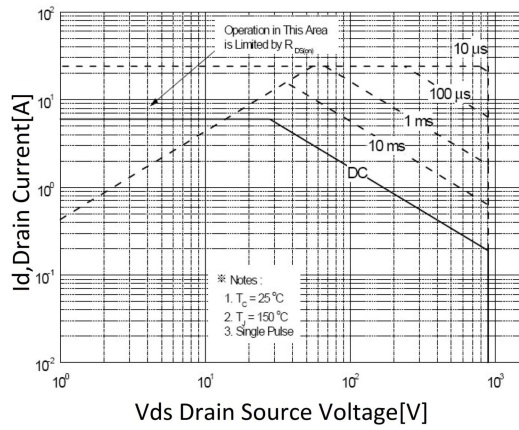

Maximum Drain Current vs. Case Temperature

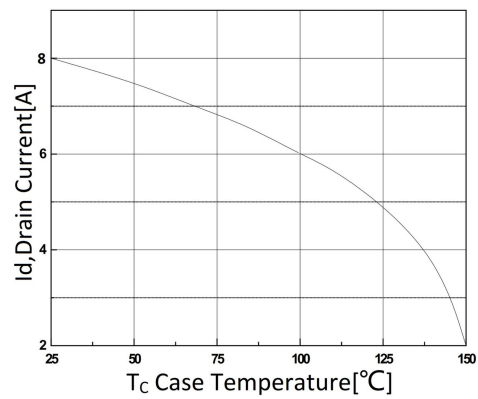

Transient Thermal Response Curve

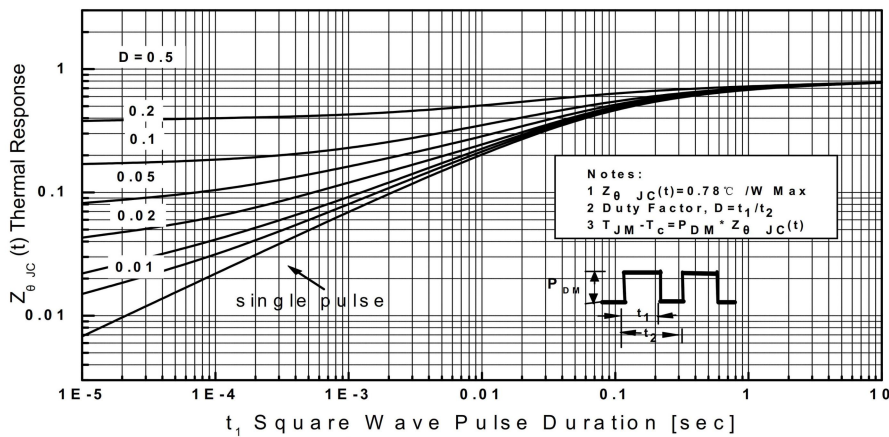

PACKAGE MECHANICAL DATA

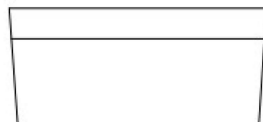
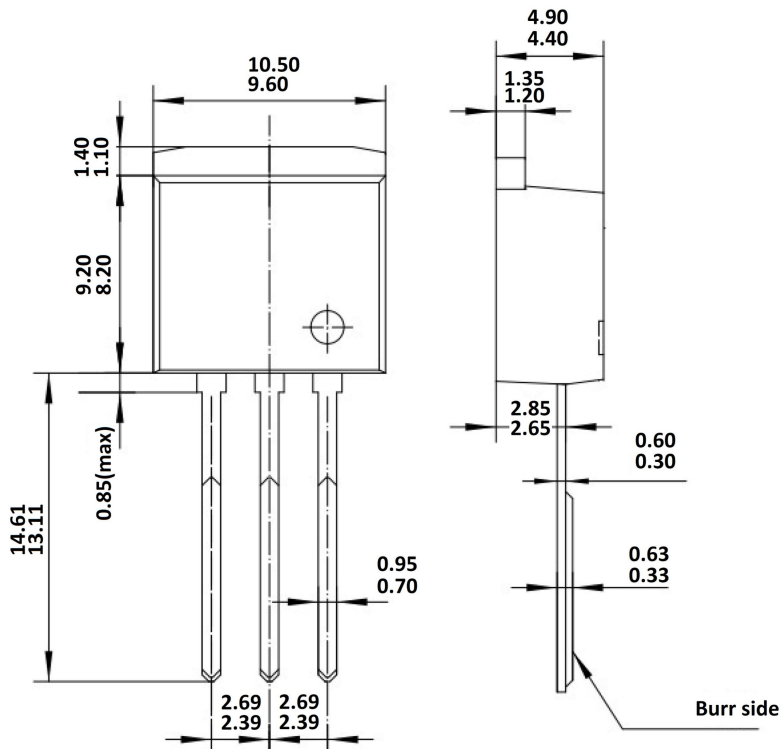
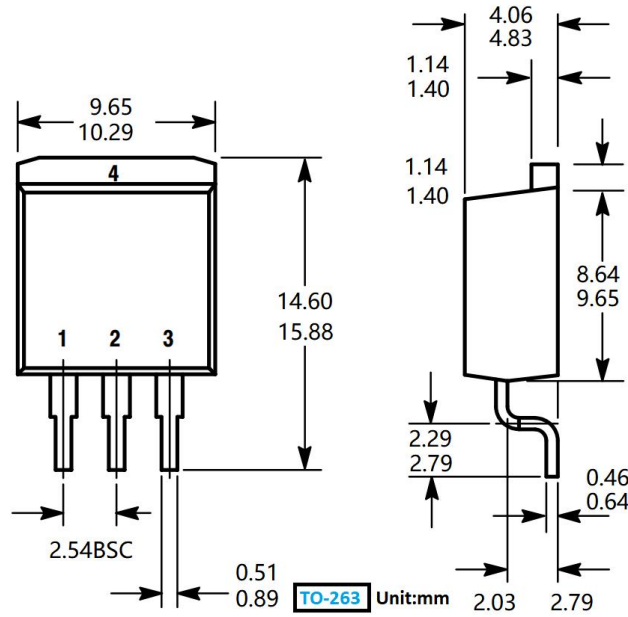

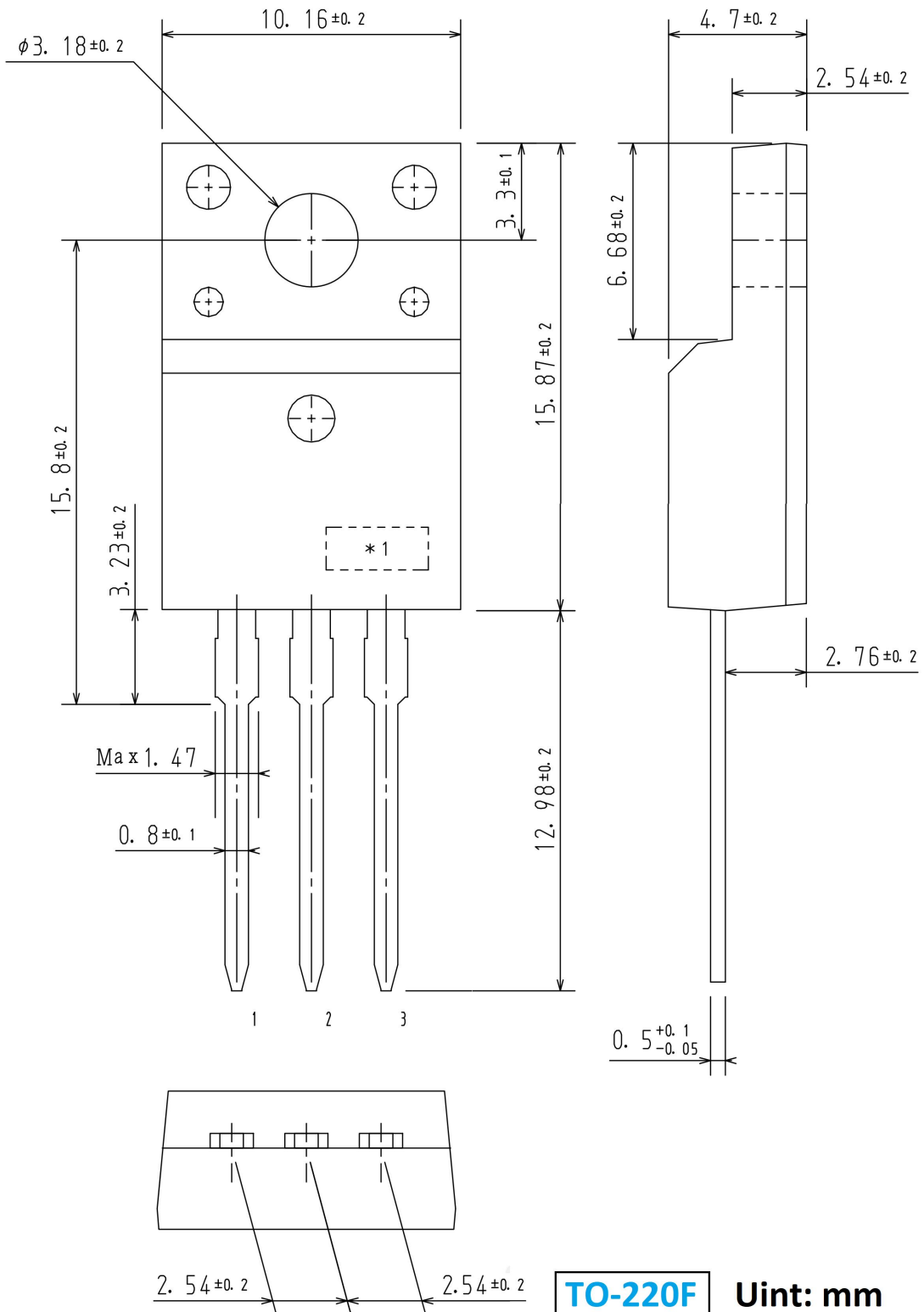

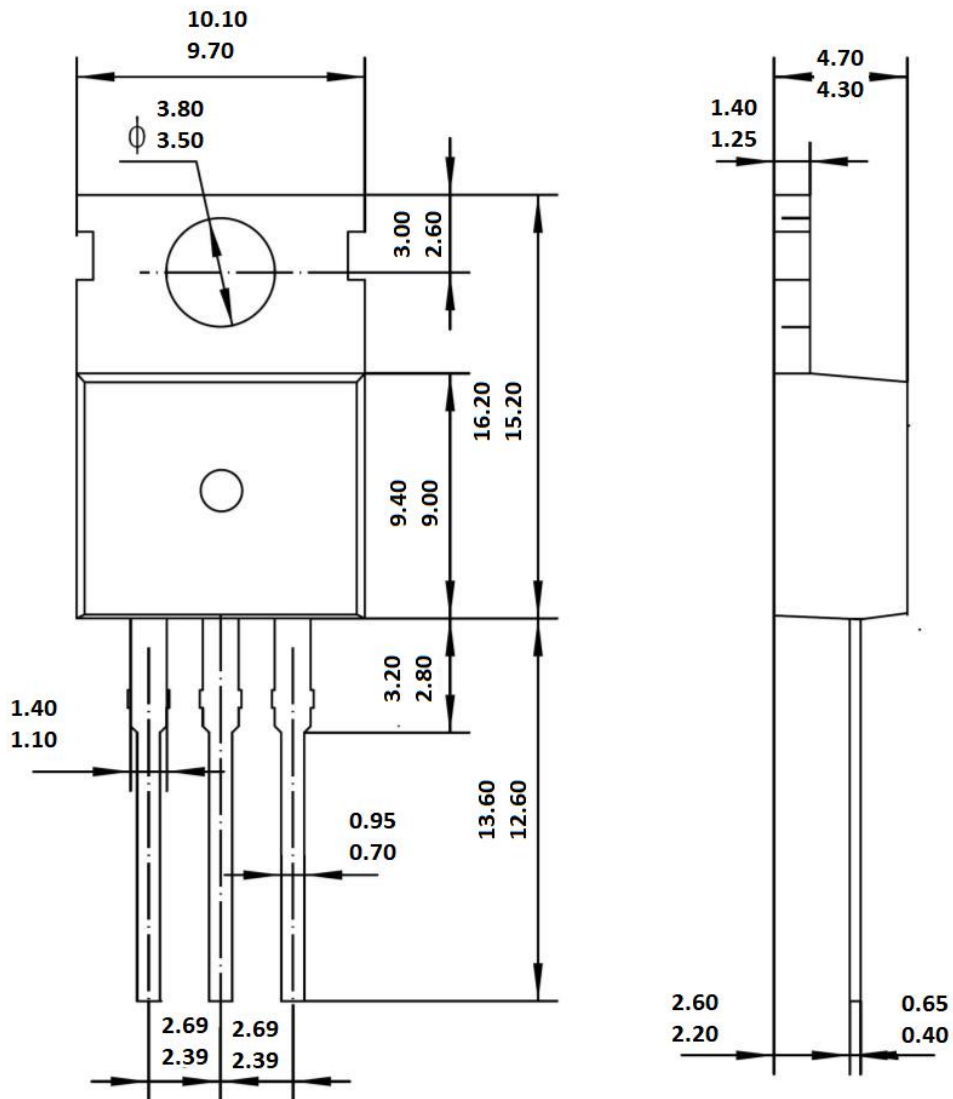

TO-220

Unit: mm

