

● Features

- 1.Current conversion ratio (CTR : MIN. 50% at $I_F = 5\text{mA}$, $V_{CE} = 5\text{V}$, $T_a = 25^\circ\text{C}$)
- 2.Insulation voltage: ($V_{ISO} = 5,000\text{Vrms}$)
- 3.High collector emitter voltage ($V_{CEO} = 70\text{V}$)
- 4.Temperature range: -55°C to 110°C
- 5.Long creepage distance: $> 8\text{mm}$, Lead-free, RoHS compliant
- 6.CQC approved(No. 15801-CQC001041-201800042)
- 7.VDE approved(No.40029733)



SMD-4

Schematic

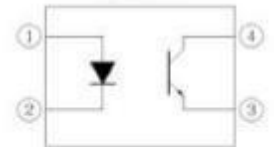

Pin configuration
 1.Anode
 2.Cathode
 3.Emitter
 4.Collector

● Illustrate

The SL-10XX series devices contain an infrared emitting diode, photo transistor detector. They are halogen and Sb2O3 free. They are packaged in a 4-pin SOP.

● Application Range

- Programmable Controller
- System devices, measuring instruments
- Telecommunication equipment
- Household appliances, such as fans and heaters
- Signal transmission between circuits of different potentials and impedance

● Max Absolute rated Value (Normal Temperature=25°C)

Parameter		Symbol	Rated Value	Unit
Input	Forward Current	I_F	60	mA
	Junction Temperature	T_J	125	$^\circ\text{C}$
	Reverse Voltage	V_R	6	V
	Consume Power	P	100	mW
Output	Collector and emitter Voltage	V_{CEO}	80	V
	Emitter and collector Voltage	V_{ECO}	7	
	Collector Current	I_C	50	mA
	Consume Power	P_C	150	mW
Total Consume Power		P_{tot}	250	mW
*1 Insulation Voltage		V_{iso}	5000	Vrms
Working Temperature		T_{opr}	-30 to + 110	$^\circ\text{C}$
Deposit Temperature		T_{stg}	-55 to + 125	
*2 Soldering Temperature		T_{sol}	260	

*1. AC testing, time 1 minute, humidity =40~60% AC Test, 1 minute, humidity = 40~60% Insulation test method as below:

- (1)Short circuit both terminals of photocoupler
- (2)No Current when testing insulation voltage
- (3)Adding sine wave voltage when testing

*2. Soldering time is 10 seconds

• Opto-electronic Characteristics

Parameter		Symbol	Condition	Min	Typ.*	Max	Unit
Input	Forward Current	V_F	$I_F=50\text{mA}$	---	1.25	1.5	V
	Reverse Voltage	I_R	$V_R=6\text{V}$	---	---	10	μA
	Collector capacitance	C_t	$V=0, f=1\text{KHz}$	---	50	---	pF
Output	Collector to emitter Current	I_{CEO}	$V_{CE}=20\text{V}, I_F=0$	---	---	100	nA
	Collector and Emitter attenuation Voltage	BV_{CEO}	$I_C=0.1\text{mA}, I_F=0$	80	---	---	V
	Emitter and Collector attenuation Voltage	BV_{ECO}	$I_E=0.1\text{mA}, I_F=0$	7	---	---	V
Transforming Characteristics	*1 Current conversion ratio	C_{TR}	$I_F=5\text{mA}, V_{CE}=5\text{V}$	50	---	600	%
	Collector Current	I_C		2.5	---	30	mA
	Collector and Emitter Saturation Voltage	$V_{CE(sat)}$	$I_F=10\text{mA}, I_C=1\text{mA}$	---	---	0.3	V
	Insulation Impedance	R_{iso}	DC500V 40~60%R.H.	10 5x10	11 1x10	---	Ω
	Floating Capacitance	C_f	$V=0, f=1\text{MHz}$	---	0.6	1	pF
	Response Time	t_r	$V_{CC}=2\text{V}, I_C=2\text{mA}, R_L=100\Omega$	---	---	18	μs
	Descend Time	t_f		---	---	18	μs

• Current Conversion Ratio = $I_C / I_F \times 100\%$

● Rank table of current transfer ratio CTR

CTR Rank	Min.	Typ.	Max.	Unit	Condition
SL-1000	50	—	600	%	IF=5mA, VCE=5V, Ta=25°C
SL-1001	100	—	160		
SL-1004	100	—	200		
SL-1005	50	—	150		
SL-1006	100	—	300		
SL-1007	80	—	160		
SL-1008	130	—	260		
SL-1009	200	—	400		
SL-1010	150	—	300		
SL-1019	250	—	500		
SL-1020	300	—	450		
SL-1002	22	—	—		
SL-1003	34	—	—		
SL-1014	56	—	—		
SL-1015	63	—	125		
SL-1018	100	—	200		
SL-1002	63	—	125	%	
SL-1003	100	—	200		

• Outer Dimension

SMD-4

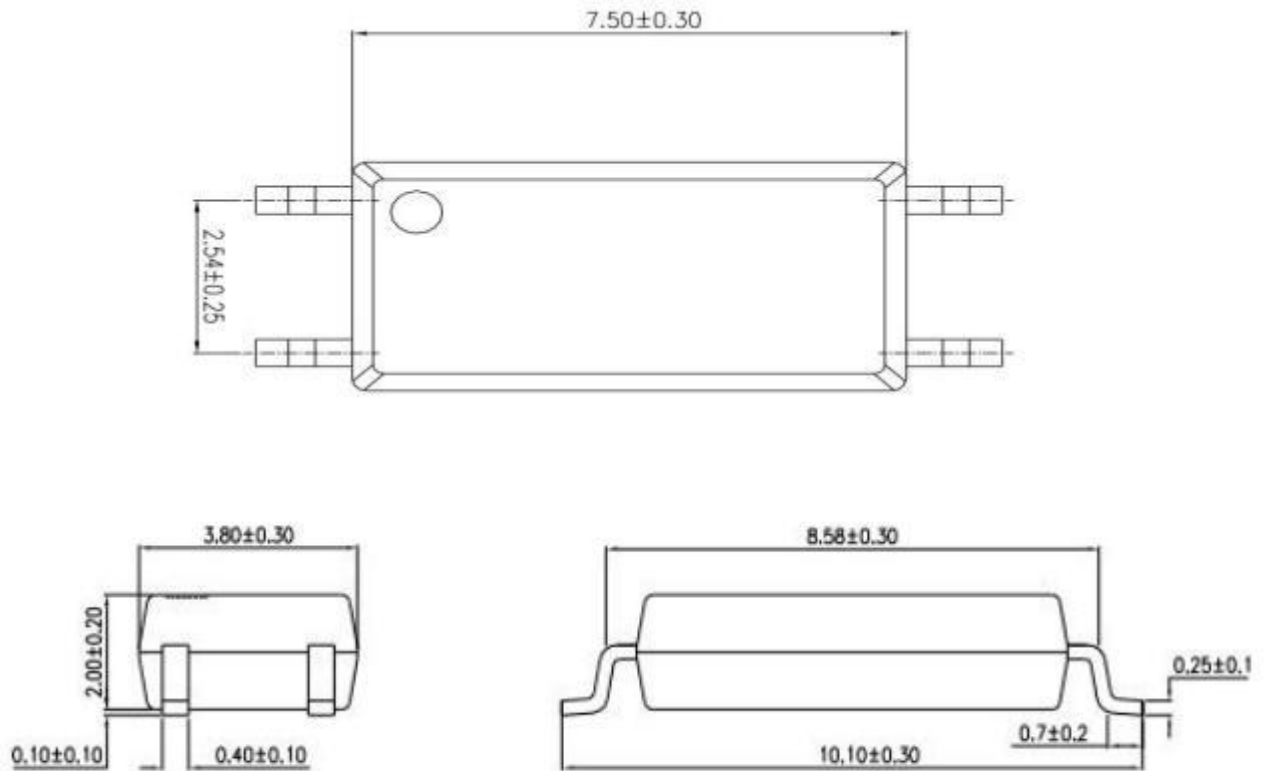

• Recommended Foot Print Patterns (Mount Pad)

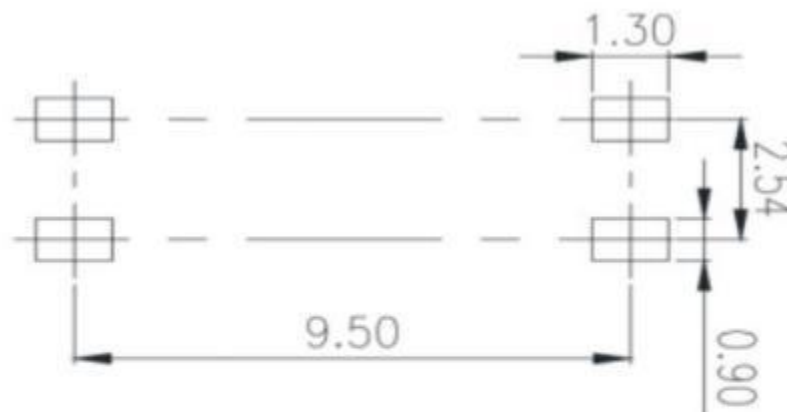

Unit: MM

• Taping Dimensions

1. SL-10XX-TP

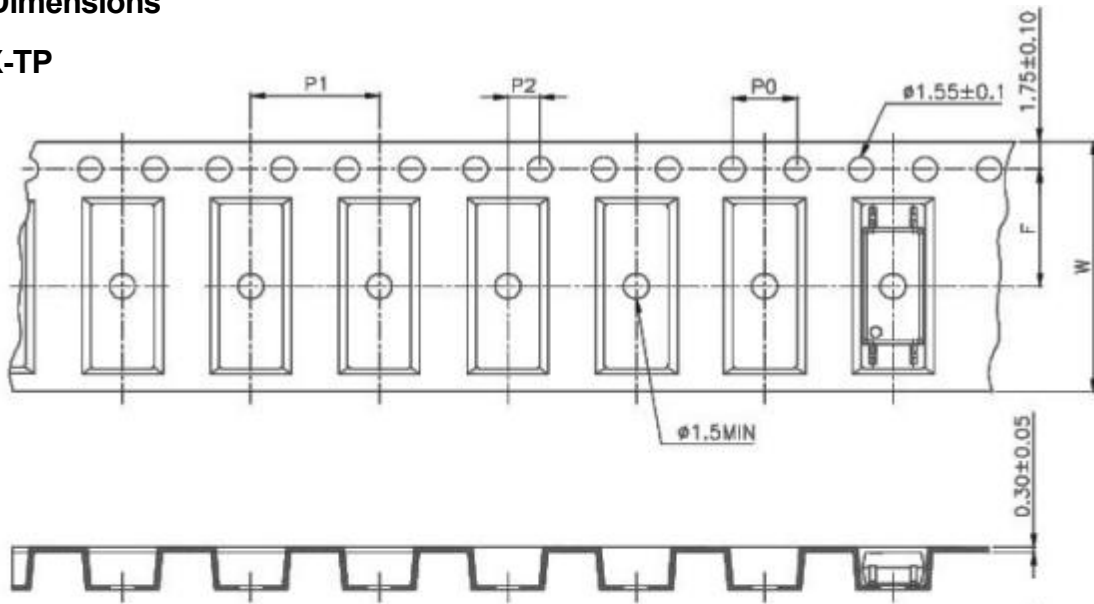

2. SL-10XX-TP1

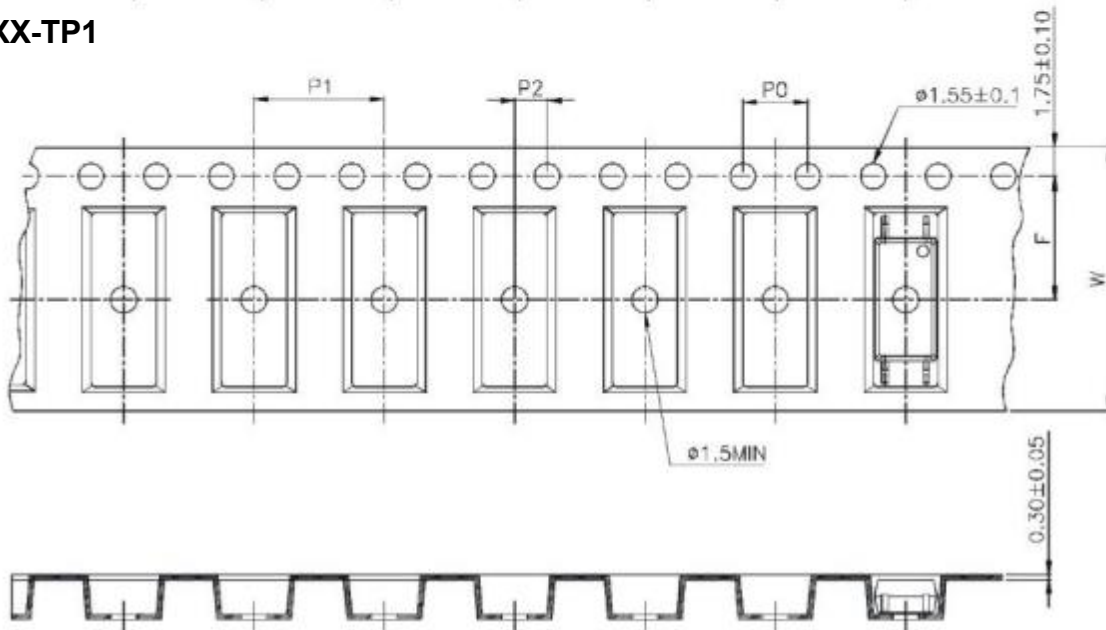

Type	Symbol	Dimensions: mm (inches)
Bandwidth	W	16±0.3(.63)
Hole distance	P0	4±0.3(.63)
Hole distance	F	7.5±0.1(.295)
	P2	2±0.1(.079)
Interval	P1	8±0.1(.315)

Package	SL-10XX series
Amount	3000

• Temperature Profile Of Soldering

1. Infrared reflow (jedec-std-020c compatible) (IR Reflow soldering (JEDEC-STD-020C compliant))

Notice: Reflow soldering is recommended under the temperature and time profiles as shown. Do not solder more than three times.

Configuration	Condition
Preheat - T _{Smin} - T _{Smax} - T _S	150°C 200°C 90±30 sec
Soldering zone - Temperature(T) - Time(t _i)	217°C 60 sec
Peak Temperature	260°C
Ramp-up rate	3°C/sec max.
3°C/sec max.	3~6°C/sec

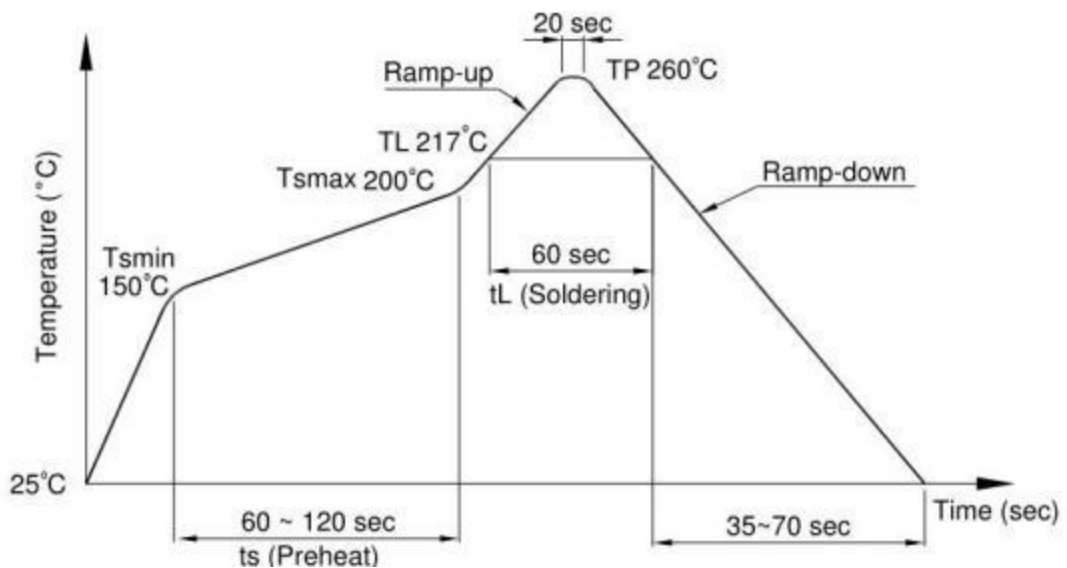

2. Wave Soldering (jedec22a111 compatible) (Wave soldering (JEDEC22A111 compliant)
 Recommended to solder at one time under temperature conditions.

Temperature	260+0/-5°C
Time	10 sec
Preheat temperature	5 to 140°C
Preheat time	30 to 80 sec

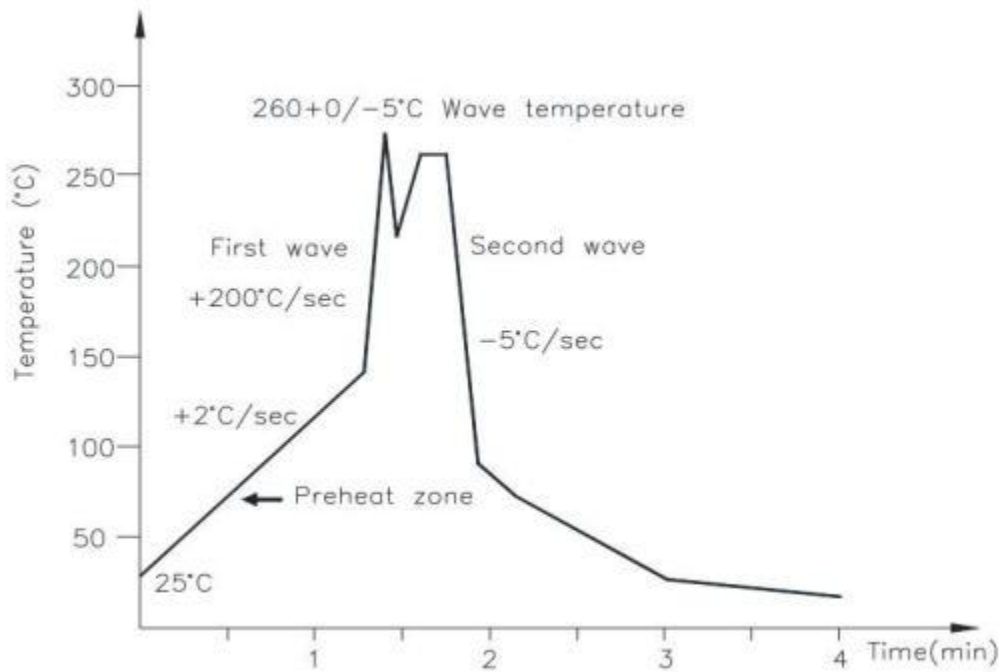

3. Hand soldering by soldering iron
 Allow single lead soldering in each process, recommended one-time soldering.

Temperature	380+0/-5, C
Time	3 sec max

• Characteristics Curve

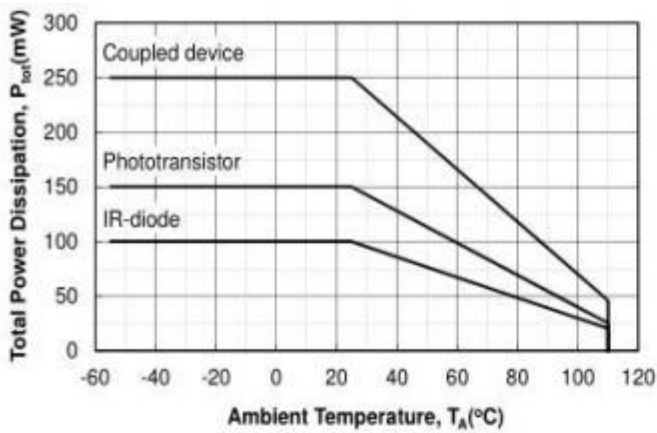

Figure 1. P_{tot} vs. T_A

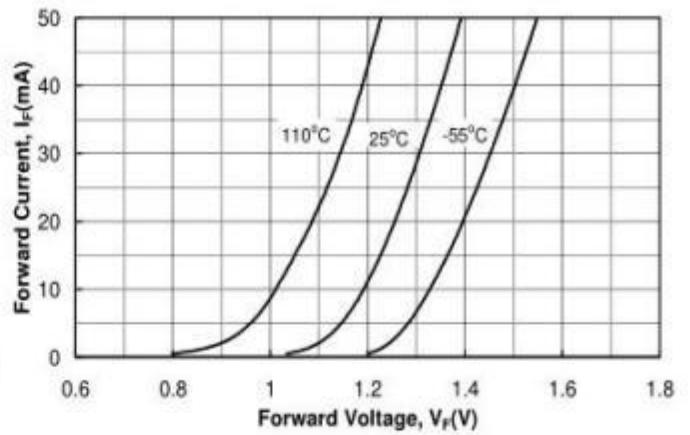

Figure 4. I_F vs. V_F

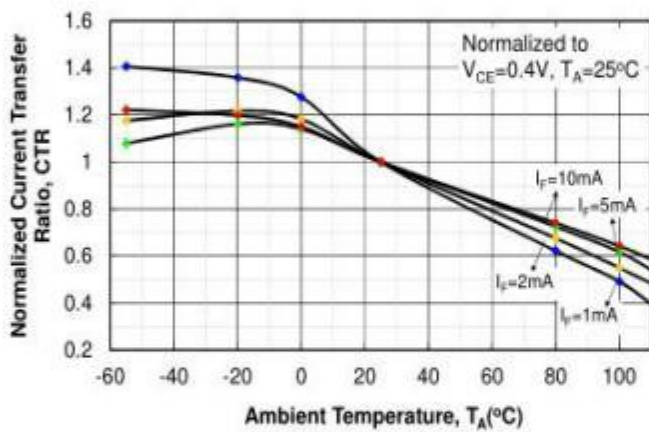

Figure 2. Saturated Normalized CTR vs. T_A

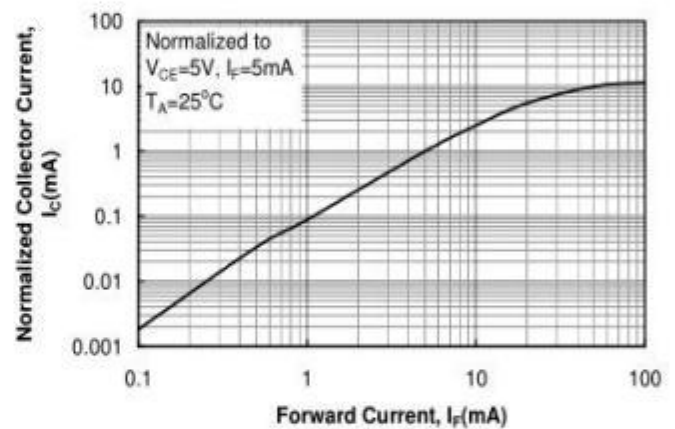

Figure 5. Normalized I_C vs. I_F

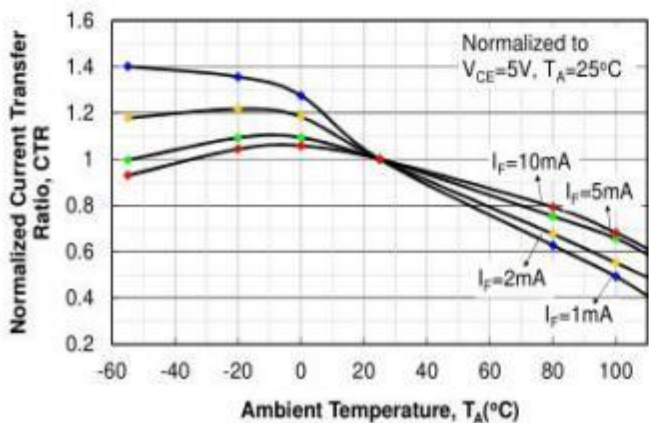

Figure 3. Non-saturated Normalized CTR vs. T_A

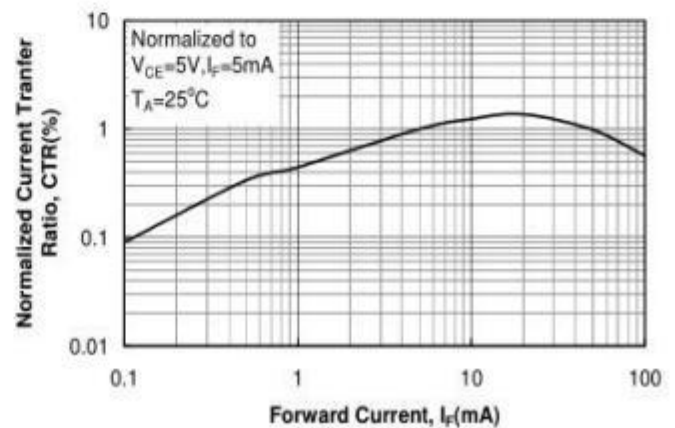

Figure 6. Normalized CTR vs. I_F

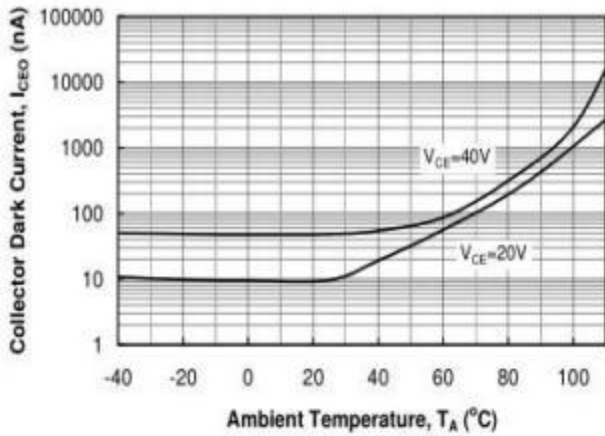

Figure 7. I_{CEO} vs. T_A

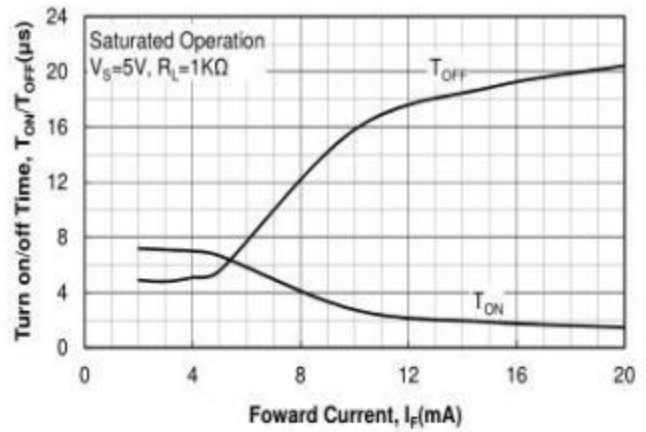

Figure 10. T_{ON} / T_{OFF} vs. I_F

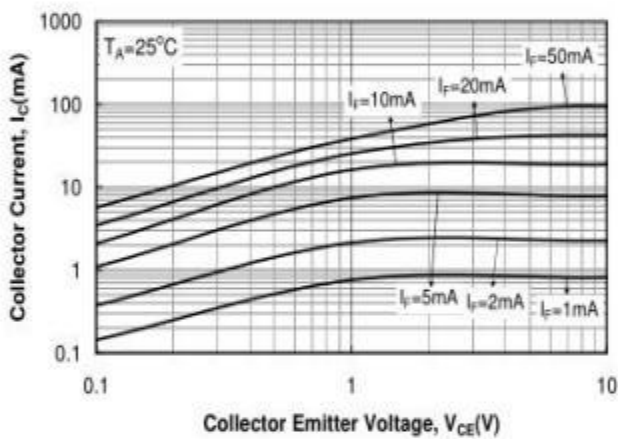

Figure 8. I_C vs. V_{CE}

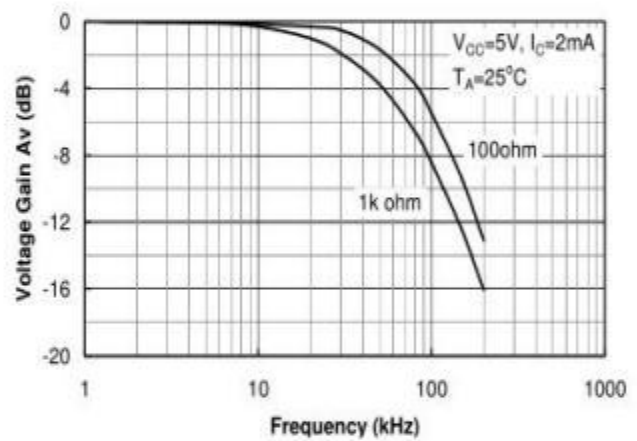

Figure 11. Frequency Response

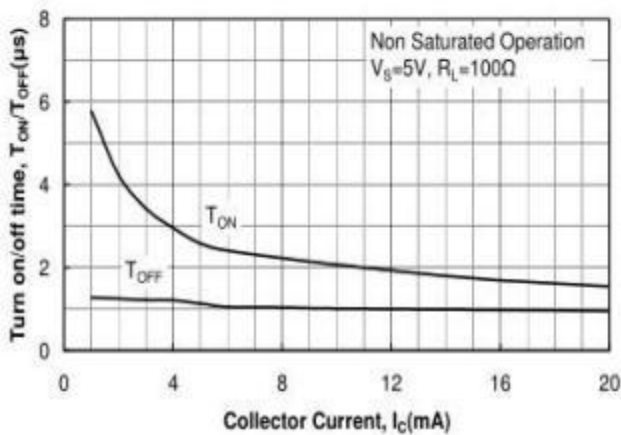

Figure 9. T_{ON} / T_{OFF} vs. I_C